

# VIRTUOSE 6D™

The Virtuose 6D is a 6 active degrees-of-freedom haptic device, specifically designed to interact in Virtual Reality environments. Thanks to its large workspace and high forces, it enables a scale one interaction with digital mock-up from the CAD.



# Virtual Reality

# Industrial Simulation

# Medical Teleoperation

# Medical Comanipulation

# Rehabilitation

## 6 ACTIVE DEGREES-OF-FREEDOM

- ✓ Passive weight balancing
- ✓ Ethernet/UDP communication system
- ✓ Removable handle, equipped with programmable buttons and a proximity sensor connected to a dead-man function
- ✓ Software interface:
  - ✓ Dedicated plug-ins for: 3DEXperience™, Catia™ & Delmia™ V5, Solidworks™
  - ✓ Drivers (binary and/or source code) available for: Python™, ROS™, CHAI3D™, ODE™, Matlab Simulink™
  - ✓ By Partner: Unity3D™

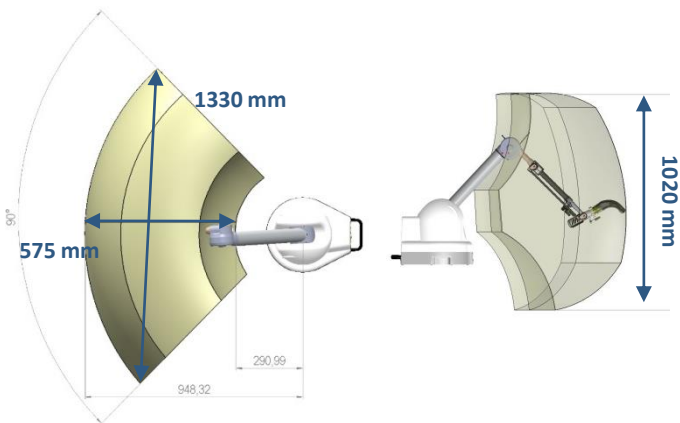
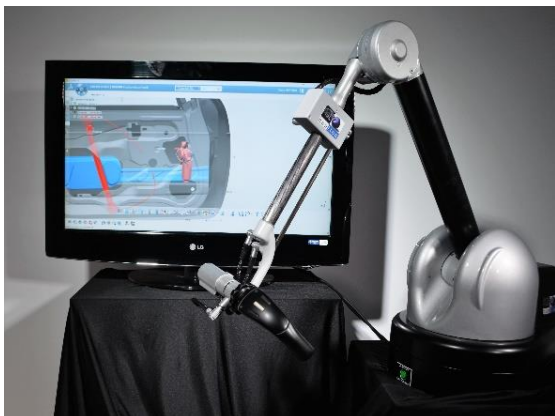

## MODULARITY

The user takes hold of the haptic device using a gripper or handle placed at the tip (called “end-effector”). The end-effector is easy to remove and replace, so that a frequent change of tool is possible, in order to customize the application and reinforce the sensation of immersion. The gripping tool is equipped with three push-buttons. One of the push-buttons is dedicated to the offset function, while the state of the other buttons can be accessed using the VIRTUOSE API.



## TECHNICAL

Translation workspace	1330 x 575 x 1020 mm
Rotation Workspace	330° x 120° x 270°
Payload (center of the workspace):	35 N (peak)/ 10 N (continuous)
Rotation force: Peak, Continuous	3.1 Nm / 1 Nm
Position resolution	0.016 mm
Rotation resolution	0.003 °
Device Weight	12 kg

## ELECTRICAL

Power supply	100-240 VAC 50/60Hz single phase
Consumption	Average consumption 200W Max consumption: 540W

## SOFTWARE

Maximum translation stiffness	2000 N/m
Maximum rotation stiffness	40Nm/rad
Update Rate	1000 Hz

The Virtuose 6D, Virtuose 6D TAO and Virtuose 3D are also available upside-down. We are available to discuss with you any specific request for integration.

## HAPTION S.A.

8 ZA Route de Laval – 53210 SOULGE SUR OUETTE – France  
 Tel. +33(0)2 43 64 51 20 Fax. +33(0)2 43 64 51 21  
 Email : [contact@haption.com](mailto:contact@haption.com) <https://www.haption.com>